



60V P-Channel Trench Power MOSFET

General Description

The SJS60P1850 uses advanced trench technology to provide excellent $R_{DS(ON)}$, low gate charge and operation with gate voltages as low as -4.5V. This device is suitable for use as a wide variety of applications.

Features

- Low Gate Charge
- 100% UIS Tested, 100% DVDS Tested
- High Power and current handling capability
- Lead free product is acquired

Application

- High side switch for full bridge converter
- DC/DC converter for LCD display

Key Performance Parametes

Parameter	Value	Unit
V_{DS}	-60	V
$R_{DS(ON_TYP)}$	175	m Ω
I_D	-1.8	A
Q_G	6.3	nC

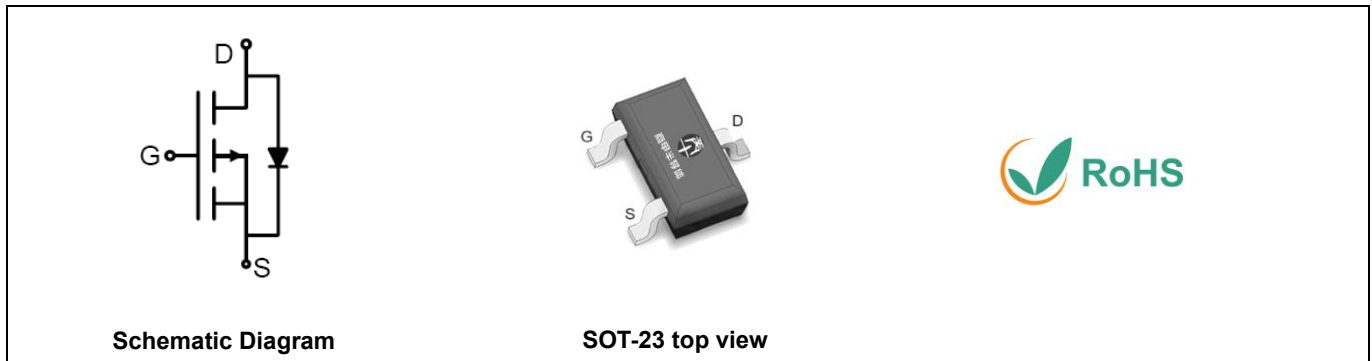

Package Marking and Ordering Information

Device/Ordering Code	Marking	Package	Packing	Reel Size	Tape width	Quantity
SJS60P1850	6001A	SOT-23	Tape	\	\	3000 Pcs

Table 1. Absolute Maximum Ratings ($T_A=25^\circ\text{C}$ unless otherwise noted)

Symbol	Parameter	Limit	Unit
V_{DS}	Drain-Source Voltage ($V_{GS}=0V$)	-60	V
V_{GS}	Gate-Source Voltage ($V_{DS}=0V$)	± 20	V
I_D	Drain Current-Continuous($T_A=25^\circ\text{C}$)	-1.8	A
	Drain Current-Continuous($T_A=100^\circ\text{C}$)	-1.1	A
I_{DM} (pluse)	Drain Current-Continuous@ Current-Pulsed (Note 1)	-7.2	A
P_D	Maximum Power Dissipation($T_A=25^\circ\text{C}$)	1.21	W
	Maximum Power Dissipation($T_A=100^\circ\text{C}$)	0.5	W
E_{AS}	Avalanche energy (Note 2)	16	mJ
T_J, T_{STG}	Operating Junction and Storage Temperature Range	-55 To 150	$^\circ\text{C}$

Table 2. Thermal Characteristic

Symbol	Parameter	Typ	Max	Unit
$R_{\theta JA}$	Thermal Resistance, Junction-to-Ambient		103	$^\circ\text{C}/\text{W}$



60V P-Channel Trench Power MOSFET

Table 3. Electrical Characteristics (T_J=25°C unless otherwise noted)

Symbol	Parameter	Conditions	Min	Typ	Max	Unit
On/Off States						
B _{VDSS}	Drain-Source Breakdown Voltage	V _{GS} =0V I _D =-250μA	-60			V
I _{DSS}	Zero Gate Voltage Drain Current	V _{DS} =-60V, V _{GS} =0V T _J =25°C			-1	μA
		V _{DS} =-60V, V _{GS} =0V T _J =125°C			-100	μA
I _{GSS}	Gate-Body Leakage Current	V _{GS} =±20V, V _{DS} =0V			±100	nA
V _{GS(th)}	Gate Threshold Voltage	V _{DS} =V _{GS} , I _D =-250μA	-1		-2.5	V
g _{FS}	Forward Transconductance	V _{DS} =-5V, I _D =-1A		2.7		S
R _{DS(ON)}	Drain-Source On-State Resistance	V _{GS} =-10V, I _D =-1A T _J =25°C		175	219	mΩ
R _{DS(ON)}	Drain-Source On-State Resistance	V _{GS} =-4.5V, I _D =-1A T _J =25°C		209	278	mΩ
Dynamic Characteristics						
C _{iss}	Input Capacitance	V _{DS} =-30V, V _{GS} =0V, f=1.0MHz		486		pF
C _{oss}	Output Capacitance			26		pF
C _{rss}	Reverse Transfer Capacitance			21		pF
R _g	Gate resistance	V _{GS} =0V, V _{DS} =0V, f=1.0MHz		18		Ω
Switching Parameters						
t _{d(on)}	Turn-on Delay Time	V _{GS} =-10V, V _{DS} =-30V, R _L =30Ω, R _{GEN} =3Ω		40		nS
t _r	Turn-on Rise Time			35		nS
t _{d(off)}	Turn-Off Delay Time			15		nS
t _f	Turn-Off Fall Time			10		nS
Q _g	Total Gate Charge	V _{GS} =-10V, V _{DS} =-30V, I _D =-1A		6.3		nC
Q _{gs}	Gate-Source Charge			0.75		nC
Q _{gd}	Gate-Drain Charge			1.35		nC
Source-Drain Diode Characteristics						
I _{SD}	Source-Drain Current (Body Diode)				-1.8	A
V _{SD}	Forward on Voltage (Note 3)	V _{GS} =0V, I _S =-1A			-1.2	V
t _{rr}	Reverse Recovery Time	I _F =-1A, di/dt=100A/μs		30		ns
Q _{rr}	Reverse Recovery Charge	I _F =-1A, di/dt=100A/μs		37		nC

Notes 1.Repetitive Rating: Pulse width limited by maximum junction temperature.

Notes 2.EAS condition: T_J=25°C, V_{DD}=-40V, V_G=-10V, R_g=25Ω, L=0.5mH.

Notes 3.Repetitive Rating: Pulse width limited by maximum junction temperature.



60V P-Channel Trench Power MOSFET

Typical Electrical And Thermal Characteristics (Curves)

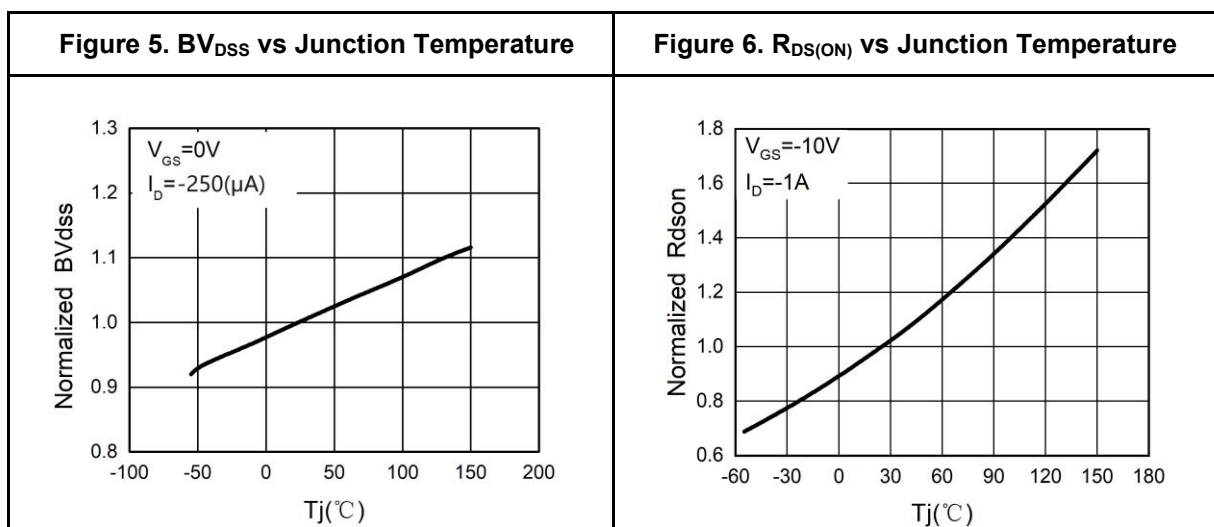
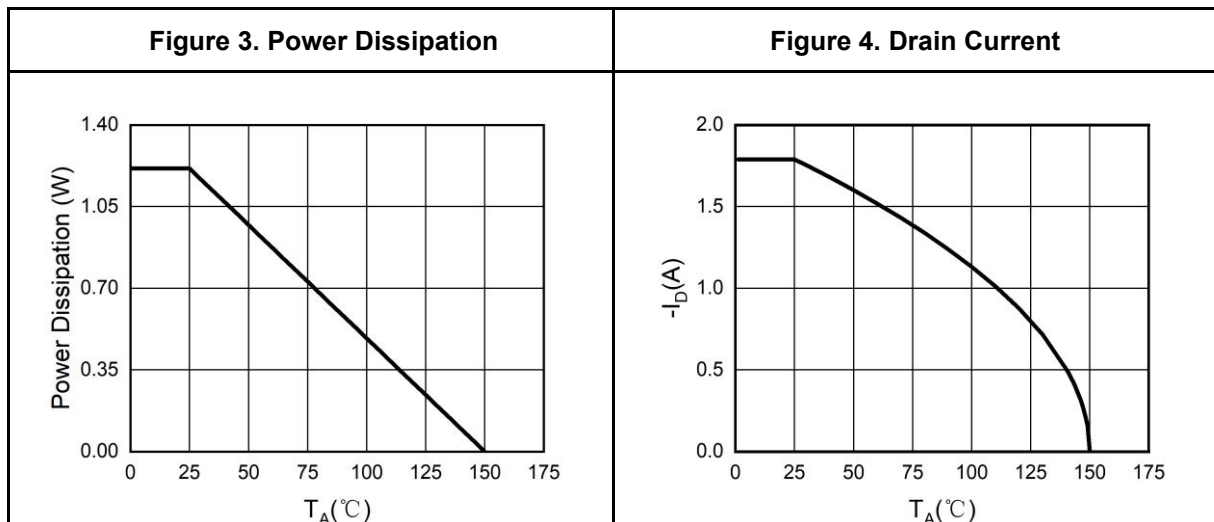
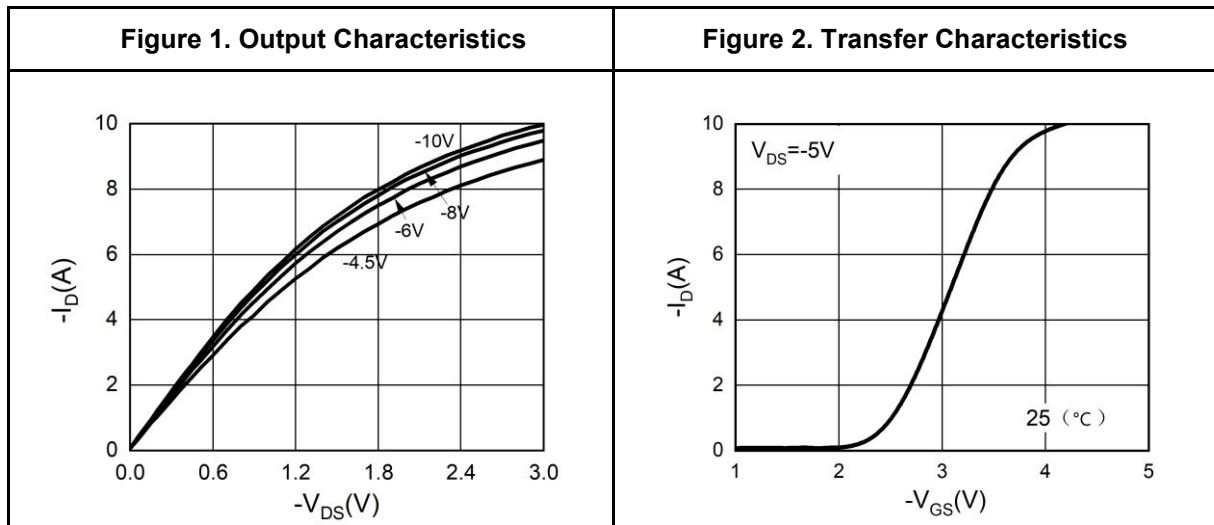



60V P-Channel Trench Power MOSFET

Typical Electrical And Thermal Characteristics (Curves)

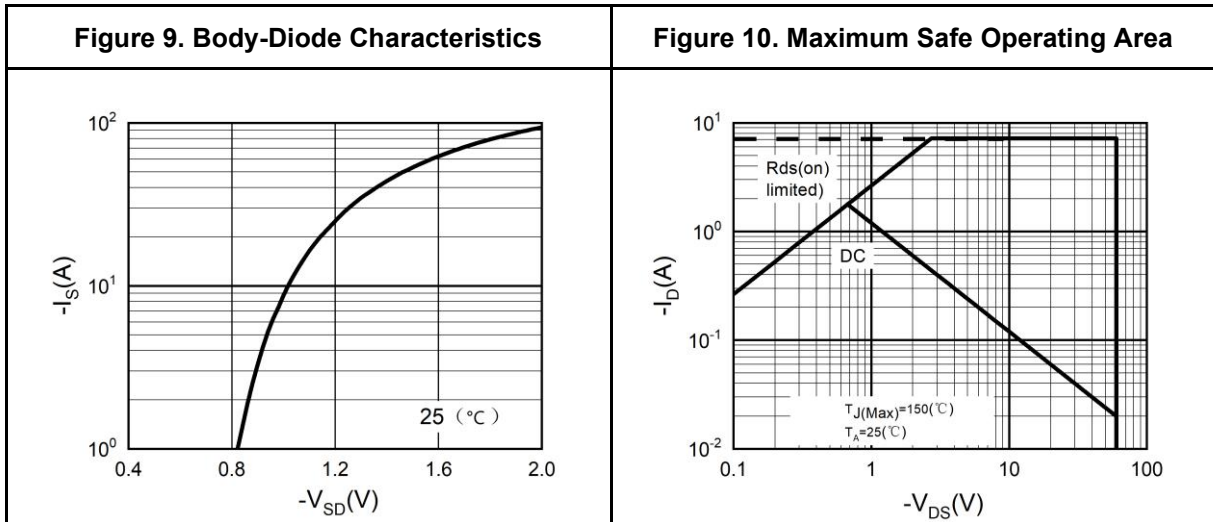
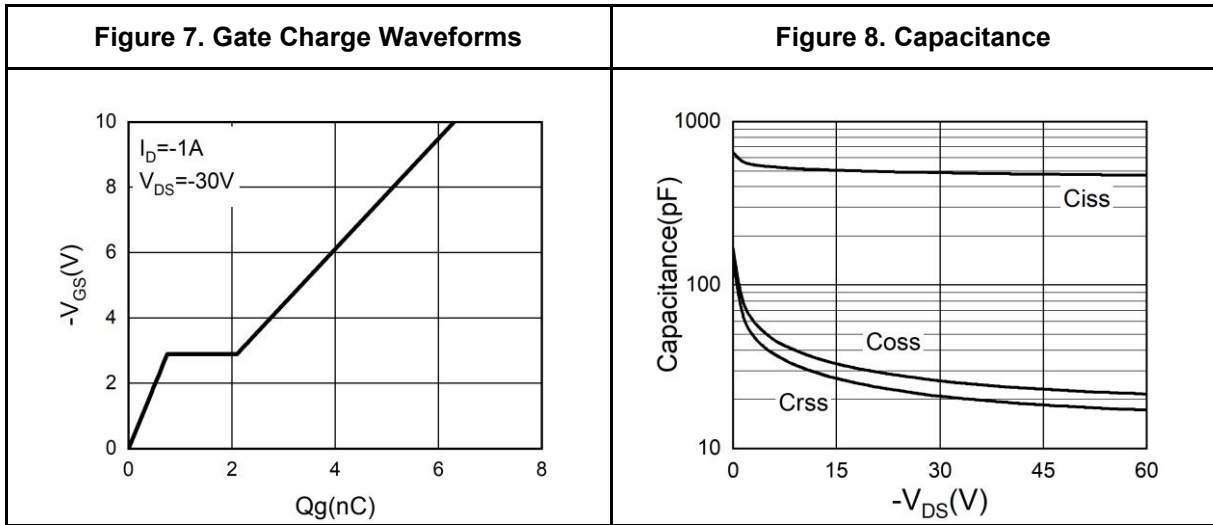



SOT-23 Package Information

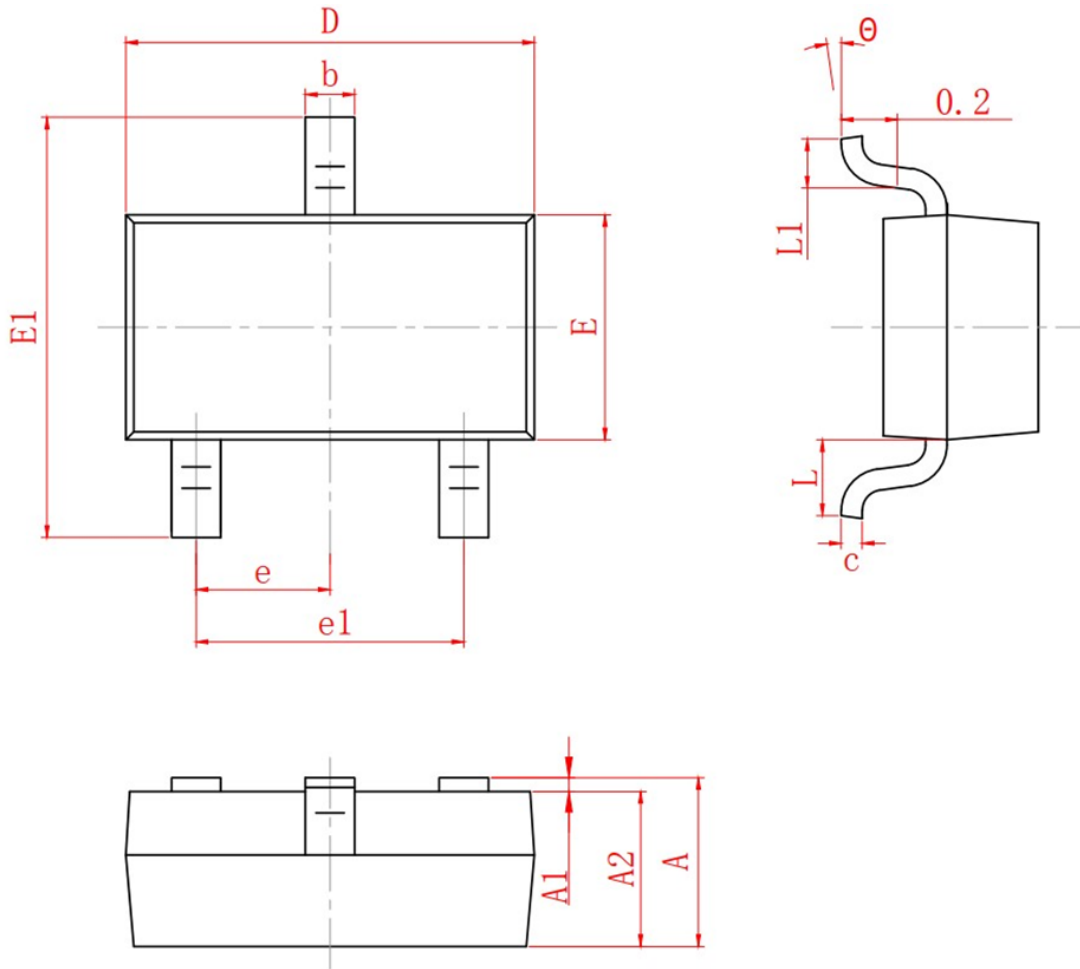

SYMBOL	MIN	NOM	MAX
A	0.90	1.05	1.20
A1	0.00	0.05	0.10
A2	0.90	1.00	1.10
b	0.30	0.40	0.50
c	0.08	0.10	0.15
D	2.80	2.90	3.00
E	1.20	1.30	1.40
E1	2.30	2.40	2.50
L	0.30	0.40	0.50
θ	0°	5°	10°
L1	0.55 REF		
e	0.95 BSC		
e1	1.90 REF		



60V P-Channel Trench Power MOSFET

Attention

This product described in this document can not be used in life support devices or systems, aircraft's control systems, and other applications whose failure can be reasonably expected to result in serious physical and/or material damage, apart from that when an application agreement is signed between customer and Wuxi Shangjia Semiconductor.

The performances and characteristics of this product in the independent testing state are displayed in this document. Wuxi Shangjia Semiconductor can't guarantee of the performances and characteristics of this described product that mounted in the customer's products or equipments as same as that in the independent testing state. So the customer should evaluate and test devices mounted in the customer's products or equipments.

Wuxi Shangjia Semiconductor reserves the right to improve the designs, functions and reliability of this product and modify any and all information described in this document without notice customer, apart from that when a notice agreement is signed between customer and Wuxi Shangjia Semiconductor.

The information given in this document shall in no event be regarded as a guarantee of conditions or characteristics. With respect to any examples or hints given herein, any typical values stated herein and/or any information regarding the application of the device, Wuxi Shangjia Semiconductor hereby disclaims any and all warranties and liabilities of any kind, including without limitation, warranties of non-infringement of intellectual property rights of any third party.