



30V N&P-Channel Trench Power MOSFET

General Description

The SJH30NP098 uses advanced trench technology to provide excellent $R_{DS(ON)}$, low gate charge and operation with gate voltages as low as 4.5V. This device is suitable for use as a wide variety of applications.

Features

- Low Gate Charge
- 100% UIS Tested, 100% DVDS Tested
- High Power and current handing capability
- Lead free product is acquired

Application

- DC/DC Converter
- Ideal for high-frequency switching and synchronous rectification

Key Performance Parametes

Parameter	Value	Value	Unit
V_{DS}	30	-30	V
$R_{DS(ON_TYP)}$	5	7.7	m Ω
I_D	81	-61	A
Q_G	25	61	nC

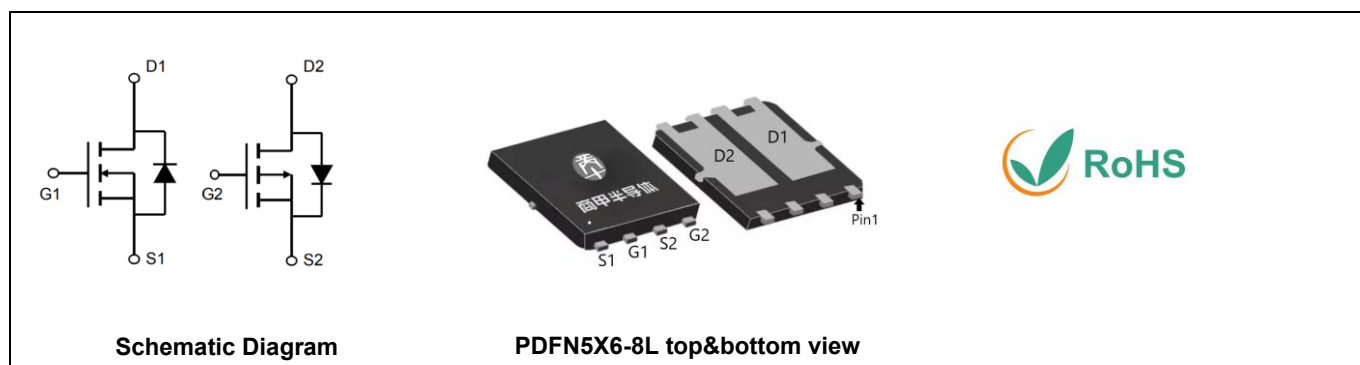

Package Marking and Ordering Information

Device/Ordering Code	Marking	Package	Packing	Reel Size	Tape width	Quantity
SJH30NP098	SJH30NP098	PDFN5X6-8L	Tape	\	\	5000 Pcs

Table 1. Absolute Maximum Ratings ($T_A=25^\circ\text{C}$ unless otherwise noted)

Symbol	Parameter	N Limit	P Limit	Unit
V_{DS}	Drain-Source Voltage ($V_{GS}=0V$)	30	-30	V
V_{GS}	Gate-Source Voltage ($V_{DS}=0V$)	± 20	± 20	V
I_D	Drain Current-Continuous($T_C=25^\circ\text{C}$)	81	-61	A
	Drain Current-Continuous($T_C=100^\circ\text{C}$)	51	-39	A
I_{DM} (pluse)	Drain Current-Continuous@ Current-Pulsed (Note 1)	324	-244	A
P_D	Maximum Power Dissipation($T_C=25^\circ\text{C}$)	66	57	W
	Maximum Power Dissipation($T_C=100^\circ\text{C}$)	26	23	W
E_{AS}	Avalanche energy (Note 2)	121	306	mJ
T_J, T_{STG}	Operating Junction and Storage Temperature Range	-55 To 150		$^\circ\text{C}$

Table 2. Thermal Characteristic

Symbol	Parameter	N Limit	P Limit	Unit
$R_{\theta JC}$	Thermal Resistance, Junction-to-Case	1.9	2.2	$^\circ\text{C}/\text{W}$



30V N&P-Channel Trench Power MOSFET

Table 3. N-Channel Electrical Characteristics ($T_J=25^\circ\text{C}$ unless otherwise noted)

Symbol	Parameter	Conditions	Min	Typ	Max	Unit
On/Off States						
BV_{DSS}	Drain-Source Breakdown Voltage	$V_{GS}=0V, I_D=250\mu A$	30			V
I_{DSS}	Zero Gate Voltage Drain Current	$V_{DS}=30V, V_{GS}=0V, T_J=25^\circ\text{C}$			1	μA
		$V_{DS}=30V, V_{GS}=0V, T_J=125^\circ\text{C}$			100	μA
I_{GSS}	Gate-Body Leakage Current	$V_{GS}=\pm 20V, V_{DS}=0V$			± 100	nA
$V_{GS(th)}$	Gate Threshold Voltage	$V_{DS}=V_{GS}, I_D=250\mu A$	1		2.5	V
g_{FS}	Forward Transconductance	$V_{DS}=5V, I_D=15A$		28		S
$R_{DS(on)}$	Drain-Source On-State Resistance	$V_{GS}=10V, I_D=15A, T_J=25^\circ\text{C}$		5	6.3	m Ω
$R_{DS(on)}$	Drain-Source On-State Resistance	$V_{GS}=4.5V, I_D=10A, T_J=25^\circ\text{C}$		6.9	9.2	m Ω
Dynamic Characteristics						
C_{iss}	Input Capacitance	$V_{DS}=15V, V_{GS}=0V, f=1.0\text{MHz}$		1740		pF
C_{oss}	Output Capacitance			192		pF
C_{rss}	Reverse Transfer Capacitance			171		pF
R_g	Gate resistance	$V_{GS}=0V, V_{DS}=0V, f=1.0\text{MHz}$		1.7		Ω
Switching Parameters						
$t_{d(on)}$	Turn-on Delay Time	$V_{GS}=10V, V_{DS}=15V, R_L=1\Omega, R_{GEN}=3\Omega$		11		nS
t_r	Turn-on Rise Time			55		nS
$t_{d(off)}$	Turn-Off Delay Time			198		nS
t_f	Turn-Off Fall Time			120		nS
Q_g	Total Gate Charge	$V_{GS}=10V, V_{DS}=15V, I_D=15A$		25		nC
Q_{gs}	Gate-Source Charge			5		nC
Q_{gd}	Gate-Drain Charge			10		nC
Source-Drain Diode Characteristics						
I_{SD}	Source-Drain Current (Body Diode)				81	A
V_{SD}	Forward on Voltage (Note 3)	$V_{GS}=0V, I_S=15A$			1.2	V
t_{rr}	Reverse Recovery Time	$I_F=15A, dI/dt=500A/\mu s$		12		ns
Q_{rr}	Reverse Recovery Charge	$I_F=15A, dI/dt=500A/\mu s$		4		nC

Notes 1.Repetitive Rating: Pulse width limited by maximum junction temperature.

Notes 2.EAS condition: $T_J=25^\circ\text{C}, V_{DD}=30V, V_G=10V, R_g=25\Omega, L=0.5\text{mH}$.

Notes 3.Repetitive Rating: Pulse width limited by maximum junction temperature.



30V N&P-Channel Trench Power MOSFET

N-Channel Typical Electrical And Thermal Characteristics (Curves)

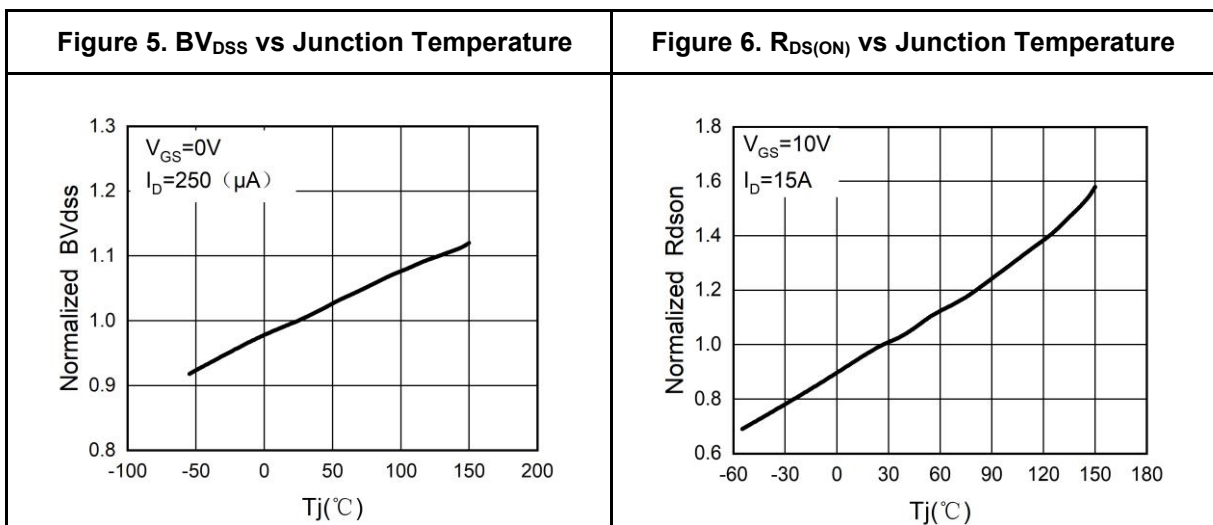
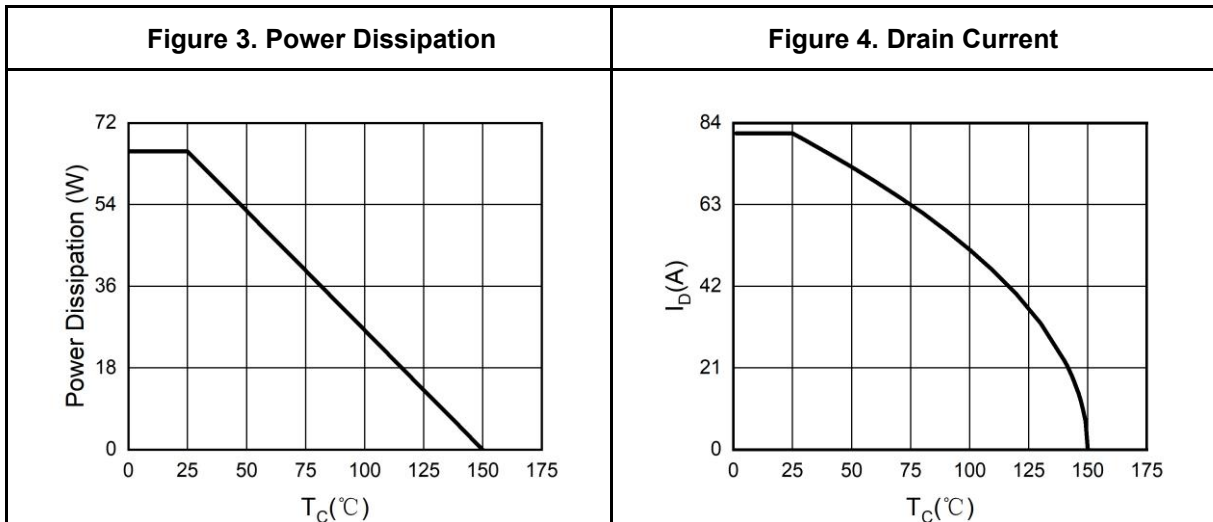
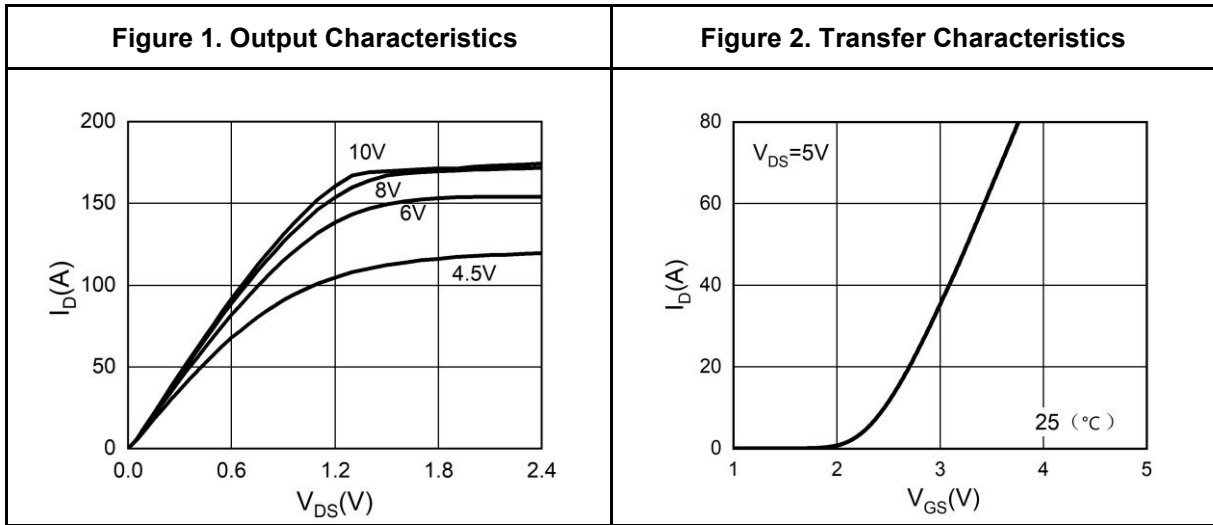



30V N&P-Channel Trench Power MOSFET

N-Channel Typical Electrical And Thermal Characteristics (Curves)

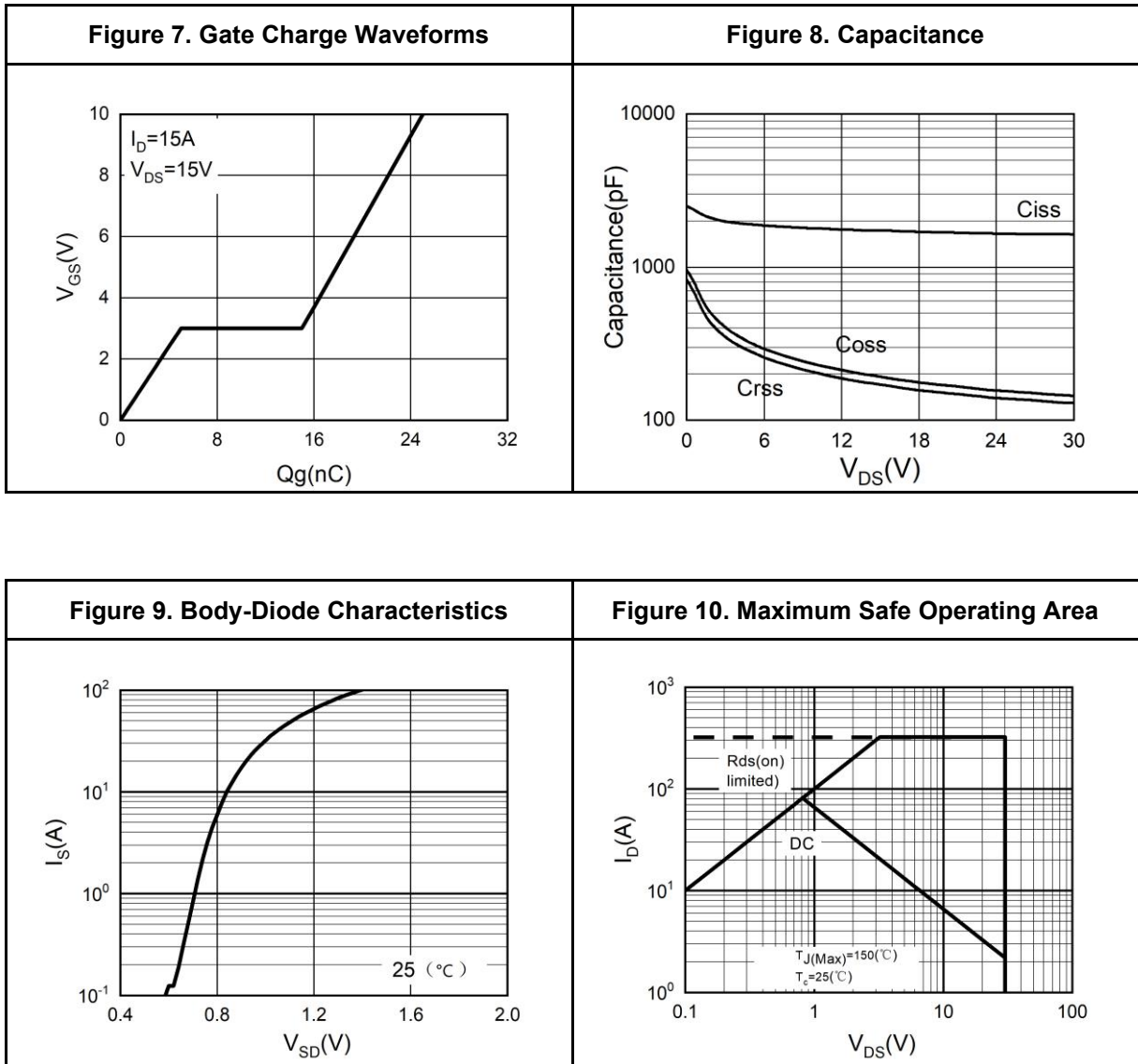



30V N&P-Channel Trench Power MOSFET

Table 4. P-Channel Electrical Characteristics ($T_J=25^\circ\text{C}$ unless otherwise noted)

Symbol	Parameter	Conditions	Min	Typ	Max	Unit
On/Off States						
BV_{DSS}	Drain-Source Breakdown Voltage	$V_{GS}=0V, I_D=-250\mu A$	-30			V
I_{DSS}	Zero Gate Voltage Drain Current	$V_{DS}=-30V, V_{GS}=0V, T_J=25^\circ\text{C}$			-1	μA
		$V_{DS}=-30V, V_{GS}=0V, T_J=125^\circ\text{C}$			-100	μA
I_{GSS}	Gate-Body Leakage Current	$V_{GS}=\pm 20V, V_{DS}=0V$			± 100	nA
$V_{GS(th)}$	Gate Threshold Voltage	$V_{DS}=V_{GS}, I_D=-250\mu A$	-1		-2.5	V
g_{FS}	Forward Transconductance	$V_{DS}=-5V, I_D=-20A$		32		S
$R_{DS(on)}$	Drain-Source On-State Resistance	$V_{GS}=-10V, I_D=-20A, T_J=25^\circ\text{C}$		7.7	9.6	m Ω
$R_{DS(on)}$	Drain-Source On-State Resistance	$V_{GS}=-4.5V, I_D=-20A, T_J=25^\circ\text{C}$		11.6	15.4	m Ω
Dynamic Characteristics						
C_{iss}	Input Capacitance	$V_{DS}=-15V, V_{GS}=0V, f=1.0\text{MHz}$		2980		pF
C_{oss}	Output Capacitance			389		pF
C_{rss}	Reverse Transfer Capacitance			363		pF
R_g	Gate resistance	$V_{GS}=0V, V_{DS}=0V, f=1.0\text{MHz}$		4.5		Ω
Switching Parameters						
$t_{d(on)}$	Turn-on Delay Time	$V_{GS}=-10V, V_{DS}=-15V, R_L=0.75\Omega, R_{GEN}=3\Omega$		21		nS
t_r	Turn-on Rise Time			18		nS
$t_{d(off)}$	Turn-Off Delay Time			26		nS
t_f	Turn-Off Fall Time			8		nS
Q_g	Total Gate Charge	$V_{GS}=-10V, V_{DS}=-15V, I_D=-20A$		61		nC
Q_{gs}	Gate-Source Charge			7.5		nC
Q_{gd}	Gate-Drain Charge			15.5		nC
Source-Drain Diode Characteristics						
I_{SD}	Source-Drain Current (Body Diode)				-61	A
V_{SD}	Forward on Voltage (Note 3)	$V_{GS}=0V, I_S=-20A$			-1.2	V
t_{rr}	Reverse Recovery Time	$I_F=-20A, dI/dt=-100A/\mu s$		15		ns
Q_{rr}	Reverse Recovery Charge	$I_F=-20A, dI/dt=-100A/\mu s$		20		nC

Notes 1.Repetitive Rating: Pulse width limited by maximum junction temperature.

Notes 2.EAS condition: $T_J=25^\circ\text{C}, V_{DD}=-30V, V_G=-10V, R_g=25\Omega, L=0.5\text{mH}$.

Notes 3.Repetitive Rating: Pulse width limited by maximum junction temperature.



30V N&P-Channel Trench Power MOSFET

P-Channel Typical Electrical And Thermal Characteristics (Curves)

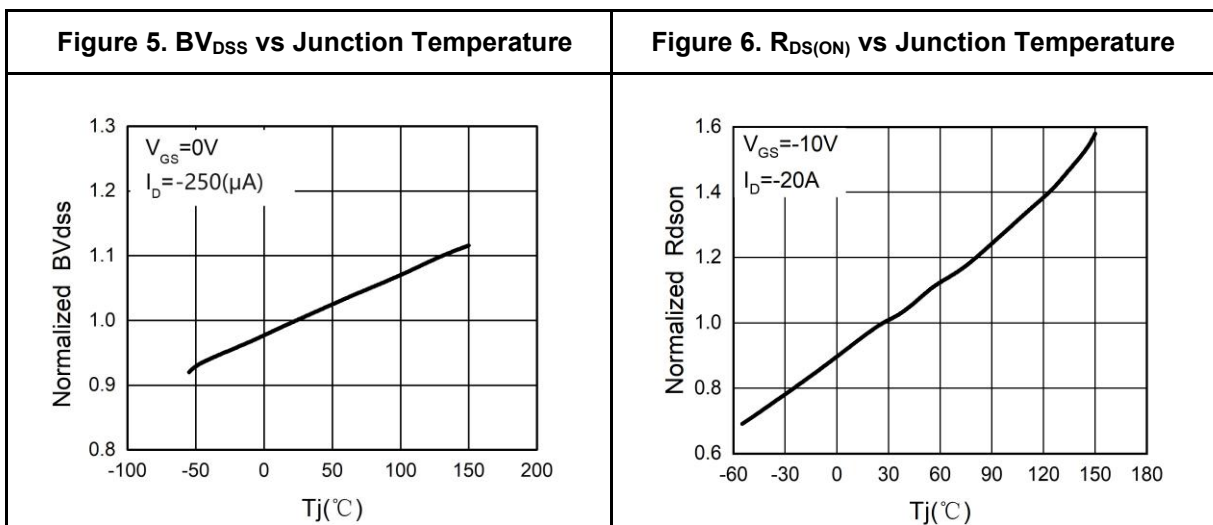
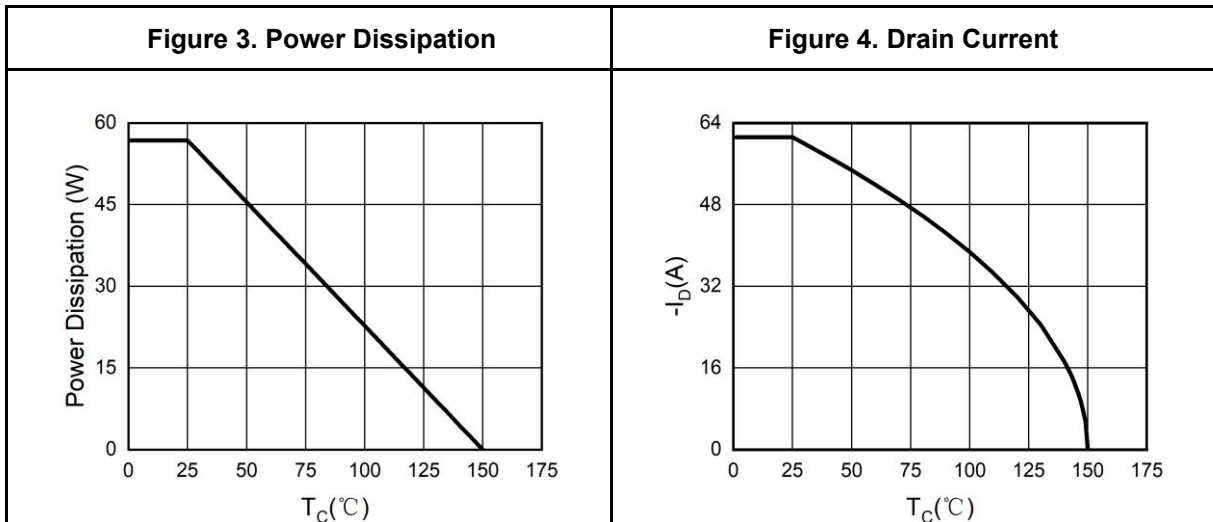
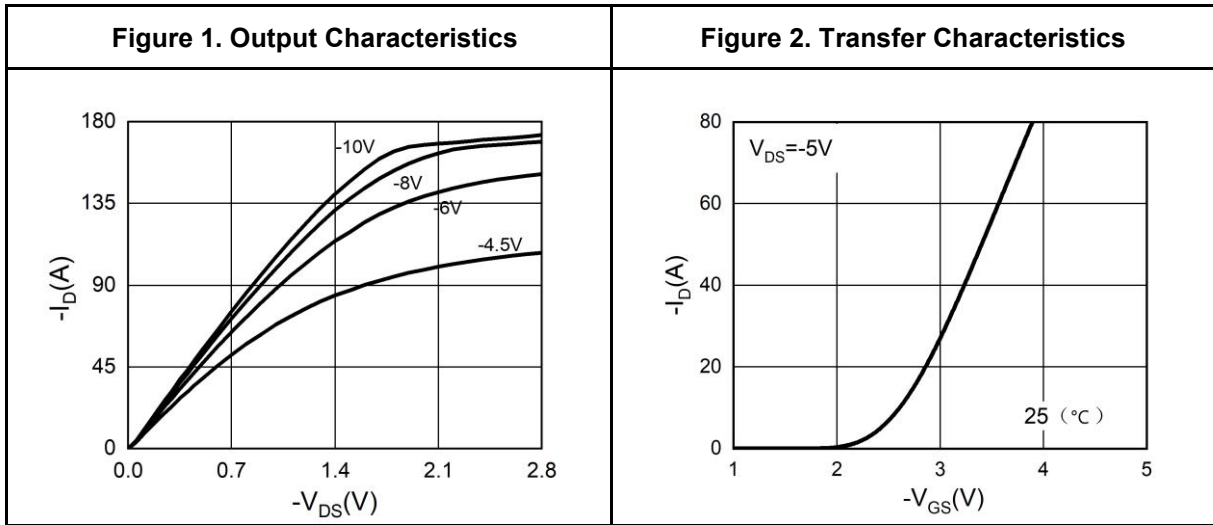



30V N&P-Channel Trench Power MOSFET

P-Channel Typical Electrical And Thermal Characteristics (Curves)

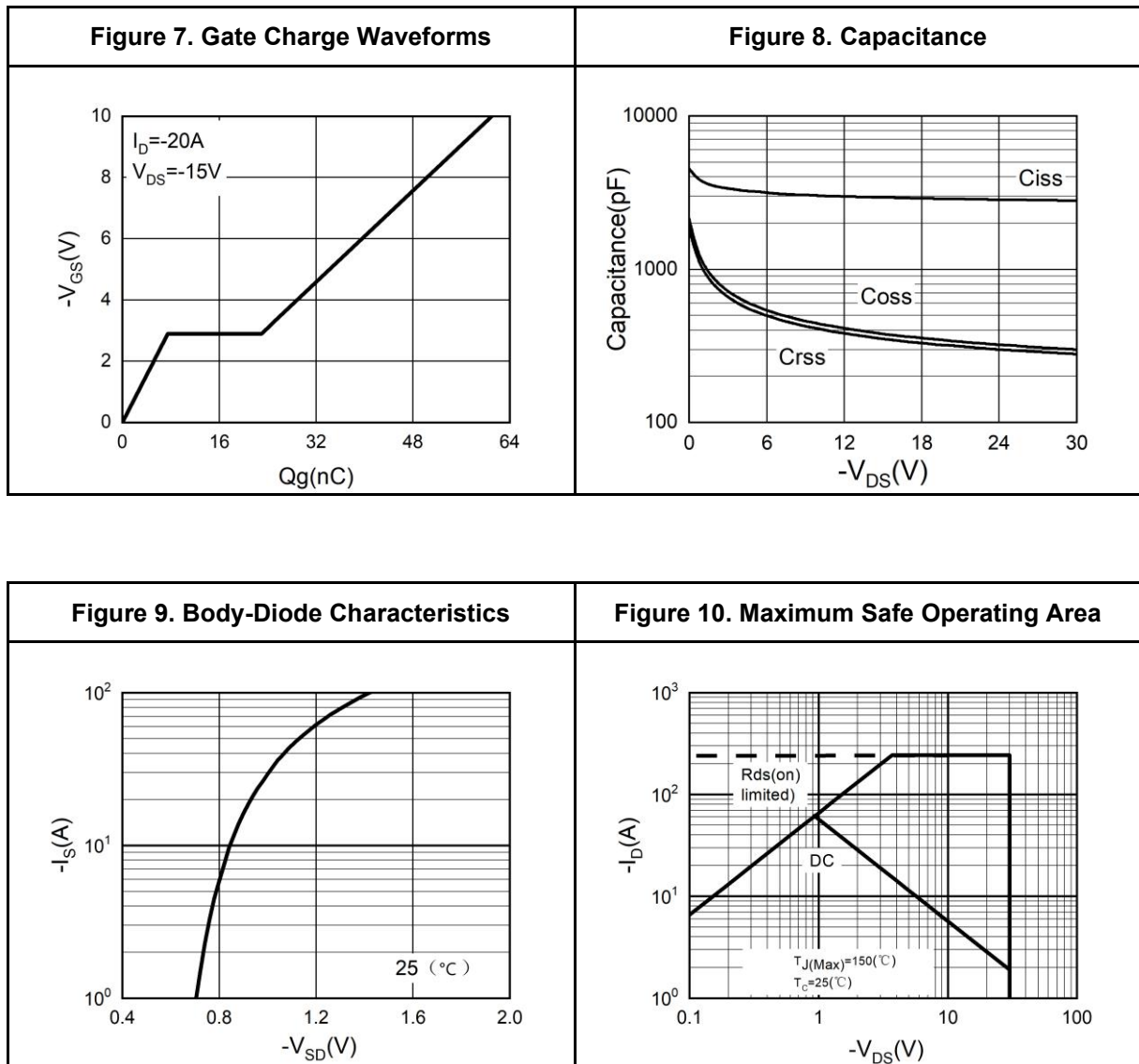



PDFN5X6-8L Package Information

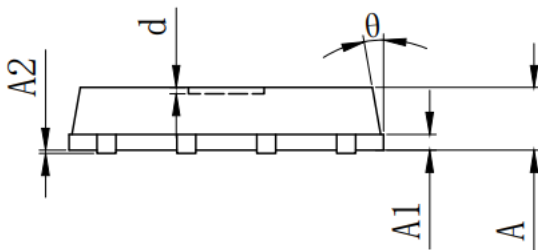
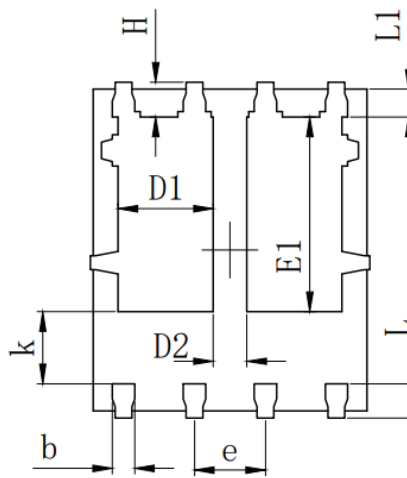
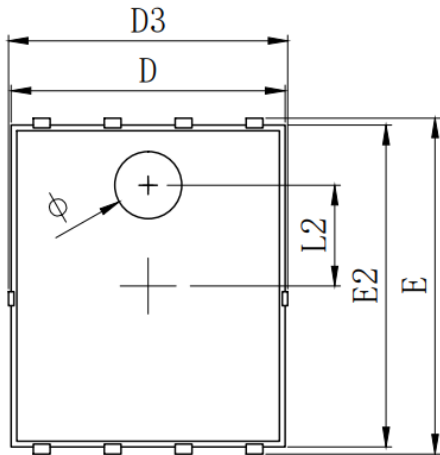

SYMBOL	MILLIMETER		
	MIN	Typ.	MAX
A	0.900	1.000	1.100
A1	0.254 REF.		
A2	0 [±] 0.05		
D	4.824	4.900	4.976
D1	1.605	1.705	1.805
D2	0.500	0.600	0.700
D3	4.924	5.000	5.076
E	5.924	6.000	6.076
E1	3.375	3.475	3.575
E2	5.674	5.750	5.826
b	0.350	0.400	0.450
e	1.270 TYP.		
L	0.534	0.610	0.686
L1	0.424	0.500	0.576
L2	1.800 REF.		
k	1.190	1.290	1.390
H	0.549	0.625	0.701
θ	8°	10°	12°
φ	1.100	1.200	1.300
d			0.100



Attention

This product described in this document can not be used in life support devices or systems, aircraft's control systems, and other applications whose failure can be reasonably expected to result in serious physical and/or material damage, apart from that when an application agreement is signed between customer and Wuxi Shangjia Semiconductor.

The performances and characteristics of this product in the independent testing state are displayed in this document. Wuxi Shangjia Semiconductor can't guarantee of the performances and characteristics of this described product that mounted in the customer's products or equipments as same as that in the independent testing state. So the customer should evaluate and test devices mounted in the customer's products or equipments.

Wuxi Shangjia Semiconductor reserves the right to improve the designs, functions and reliability of this product and modify any and all information described in this document without notice customer, apart from that when an notice agreement is signed between customer and Wuxi Shangjia Semiconductor.

The information given in this document shall in no event be regarded as a guarantee of conditions or characteristics. With respect to any examples or hints given herein, any typical values stated herein and/or any information regarding the application of the device, Wuxi Shangjia Semiconductor hereby disclaims any and all warranties and liabilities of any kind, including without limitation, warranties of non-infringement of intellectual property rights of any third party.